



Installation instructions, accessories

Volvo Car Corporation Gothenburg, Sweden

Instruction No	Version	Part. No.
31414732	1.0	31414909, 31414910, 31408796, 31408797

Combi instruments



Installation instructions, accessories

Volvo Car Corporation Gothenburg, Sweden

Equipment

VIDA

IMG-242205

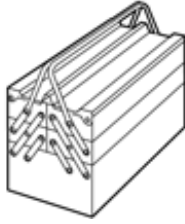

IMG-345497

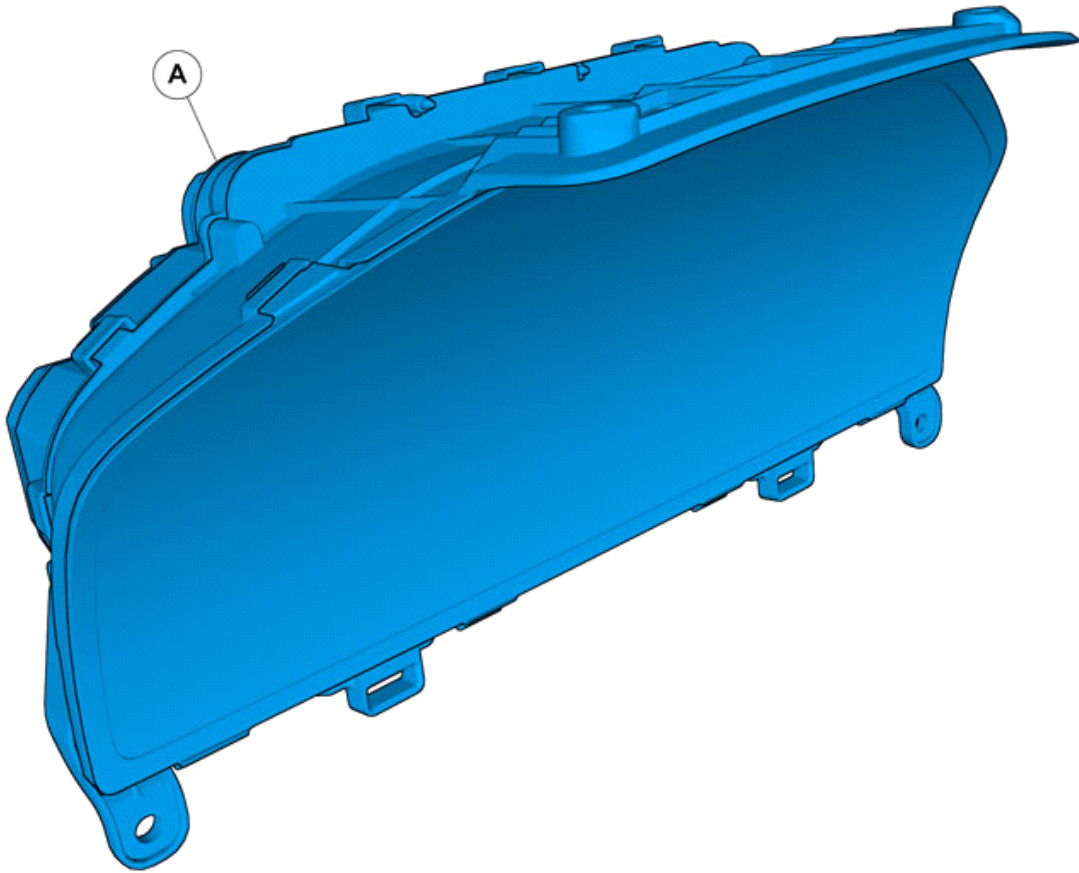

IMG-380850



Installation instructions, accessories

Volvo Car Corporation Gothenburg, Sweden

Information

1

Read through all of the instructions before starting installation.

Notifications and warning texts are for your safety and to minimise the risk of something breaking during installation.

Ensure that all tools stated in the instructions are available before starting installation.

Certain steps in the instructions are only presented in the form of images. Explanatory text is also given for more complicated steps.

In the event of any problems with the instructions or the accessory, contact your local Volvo dealer.

Color symbols

2

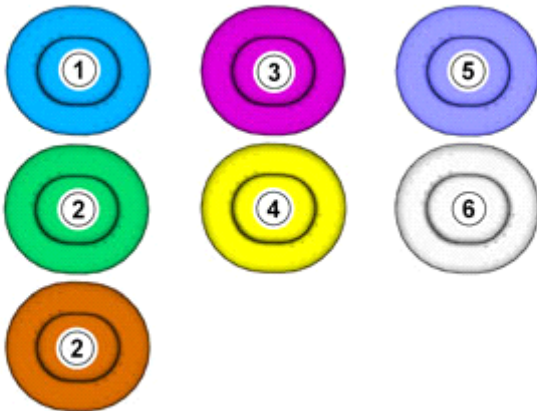

IMG-363036

Note!

This colour chart displays (in colour print and electronic version) the importance of the different colours used in the images of the method steps.

1. Used for focused component, the component with which you will do something.
2. Used as extra colors when you need to show or differentiate additional parts.
3. Used for attachments that are to be removed/installed. May be screws, clips, connectors, etc.
4. Used when the component is not fully removed from the vehicle but only hung to the side.
5. Used for standard tools and special tools.
6. Used as background color for vehicle components.

Removal



Installation instructions, accessories

Volvo Car Corporation Gothenburg, Sweden

3

Set the ignition key to position 0.



IMG-332193

4

Release the lock.

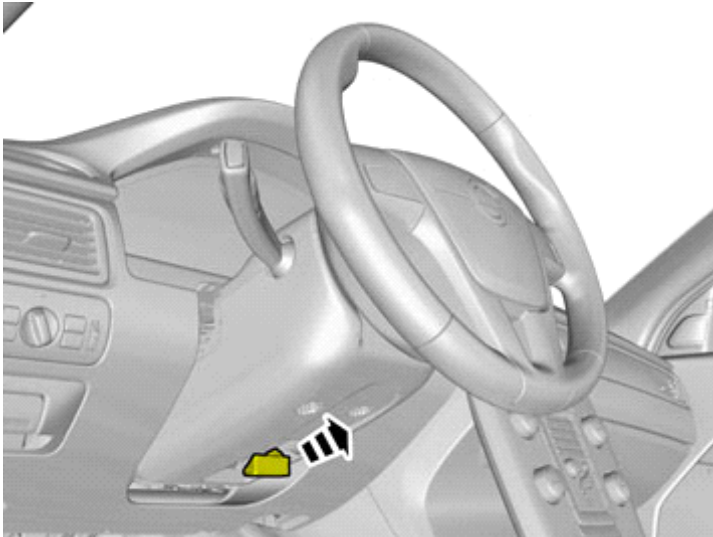

IMG-344717

5

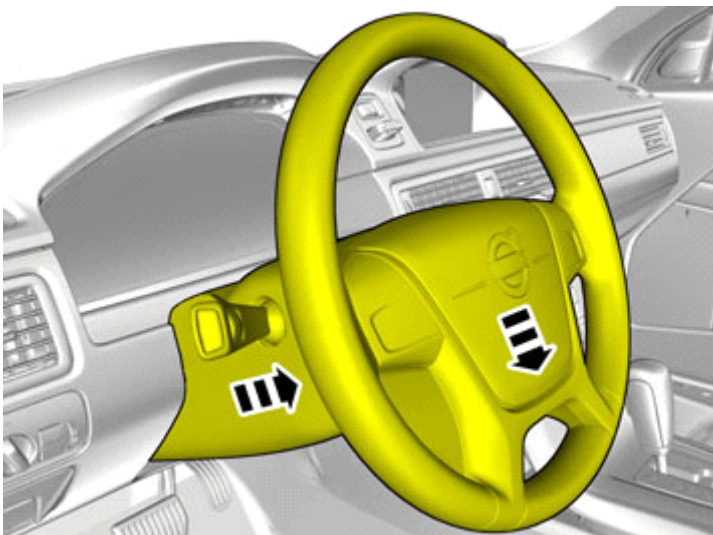

IMG-354468



Installation instructions, accessories

Volvo Car Corporation Gothenburg, Sweden

6

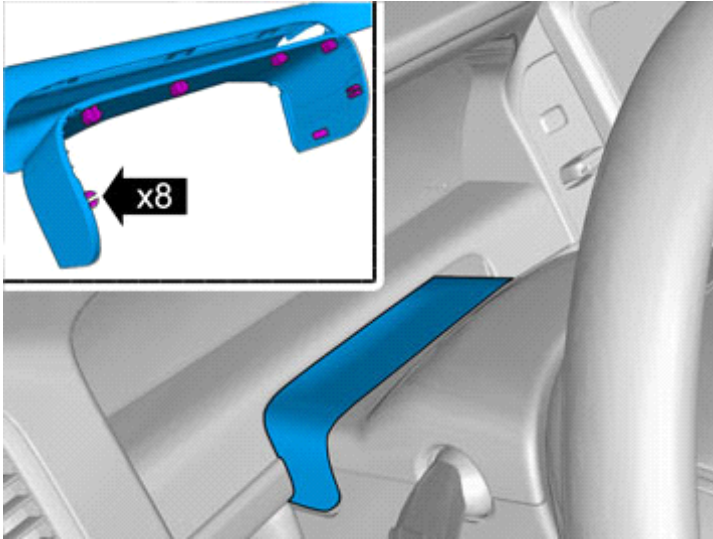

IMG-356552

7

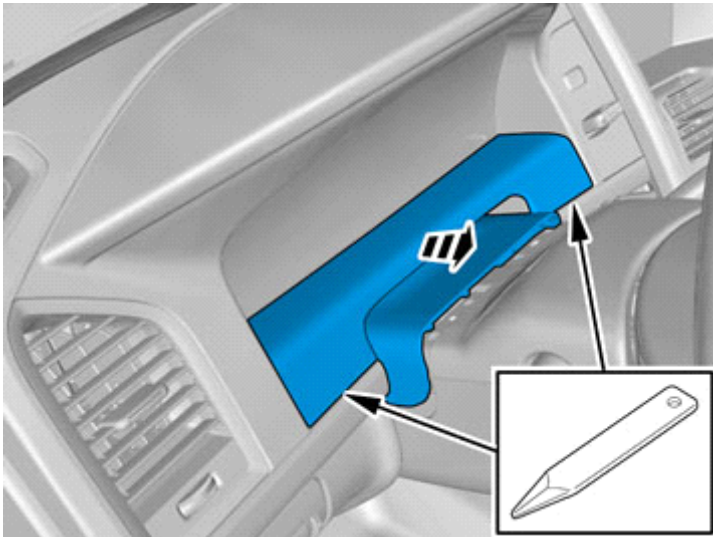

IMG-356543

Remove the panel.

8

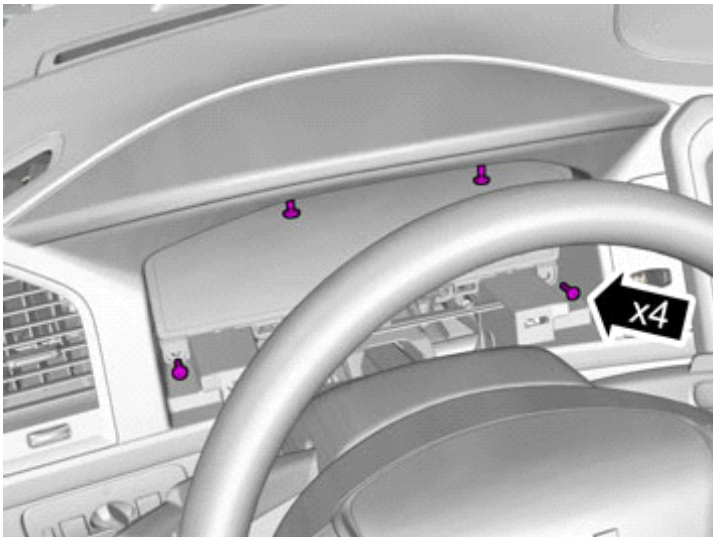

IMG-347732

Remove the screws.



Installation instructions, accessories

Volvo Car Corporation Gothenburg, Sweden

9

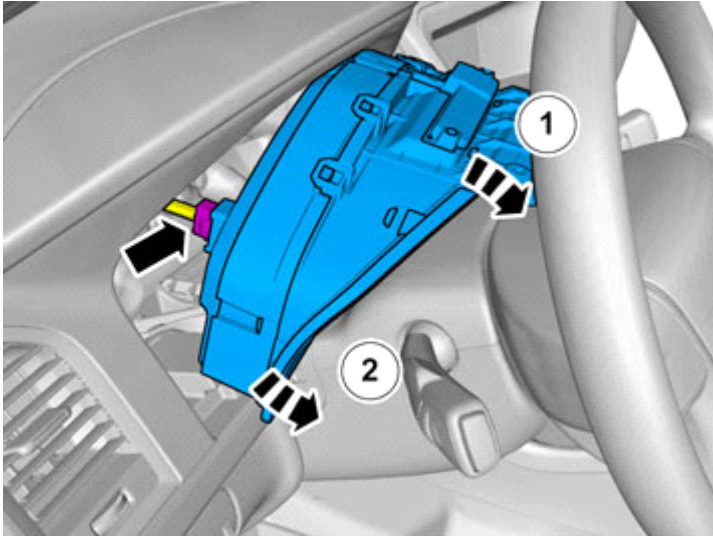

IMG-347726

Disconnect the connector.

The part is not to be reused.

Accessory installation

10

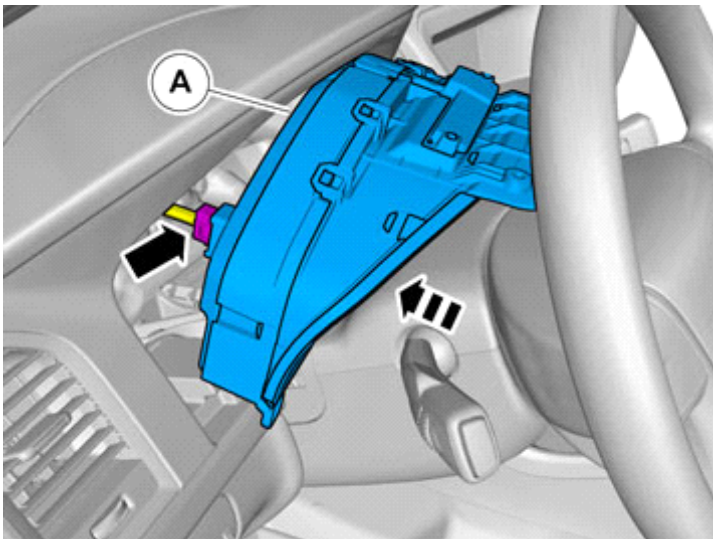

IMG-380879

Install component that comes with the accessory kit.



Installation instructions, accessories

Volvo Car Corporation Gothenburg, Sweden

11

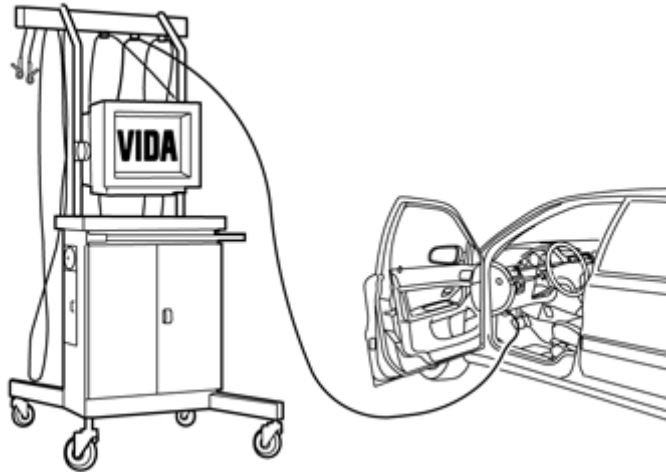

IMG-242268

Download software (application) for the accessory's function according to the service information in VIDA. See VIDA or the accessories catalogue for software part number.

12

Reinstall the removed parts in reverse order.

IMG-377070